

REV	DESCRIPTION	APRVD/DATE
△ ¹		

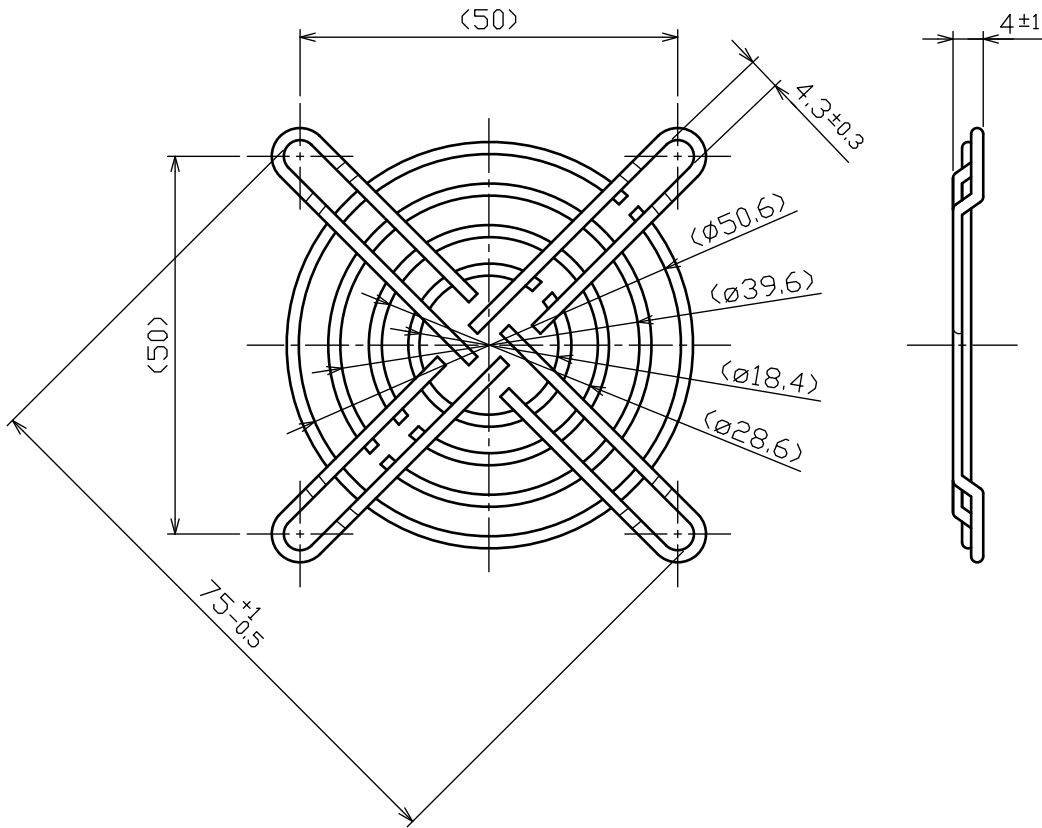

注) 1. 無記号公差: ±1
 2. () 寸は参考寸法を示す。

ALLOWANCE				RoHS指令適用品 RoHS DIRECTIVE APPLIED		
	MATERIAL SWRM φ1.6			MODEL/TITLE		
	FINISH ニッケルクロムメッキ			PART NAME フィンガーガード (60角ファン対象)		
	THIRD ANGLE PROJECTION UNIT:m/m			SCALE: --	型番	
	DESIGN	CHECKED	CHECKED	APPROVED	TD-60A-N	
	<i>Tomita</i>		<i>Shinozaki</i>	<i>Maejima</i>	函番	
DON'T SCALE THIS DWG.	Aug 26 '14	Aug 26 '14	Aug 26 '14	D-42793		

000
0